

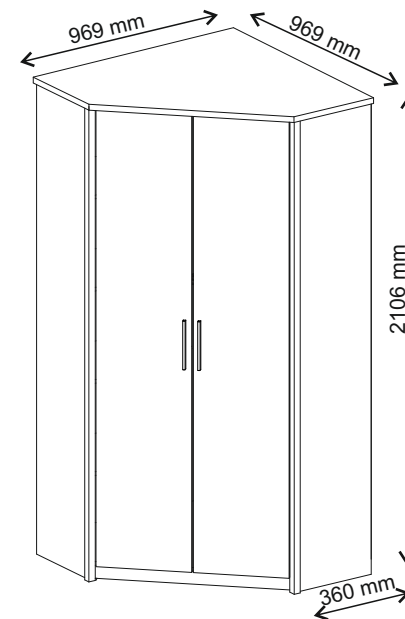

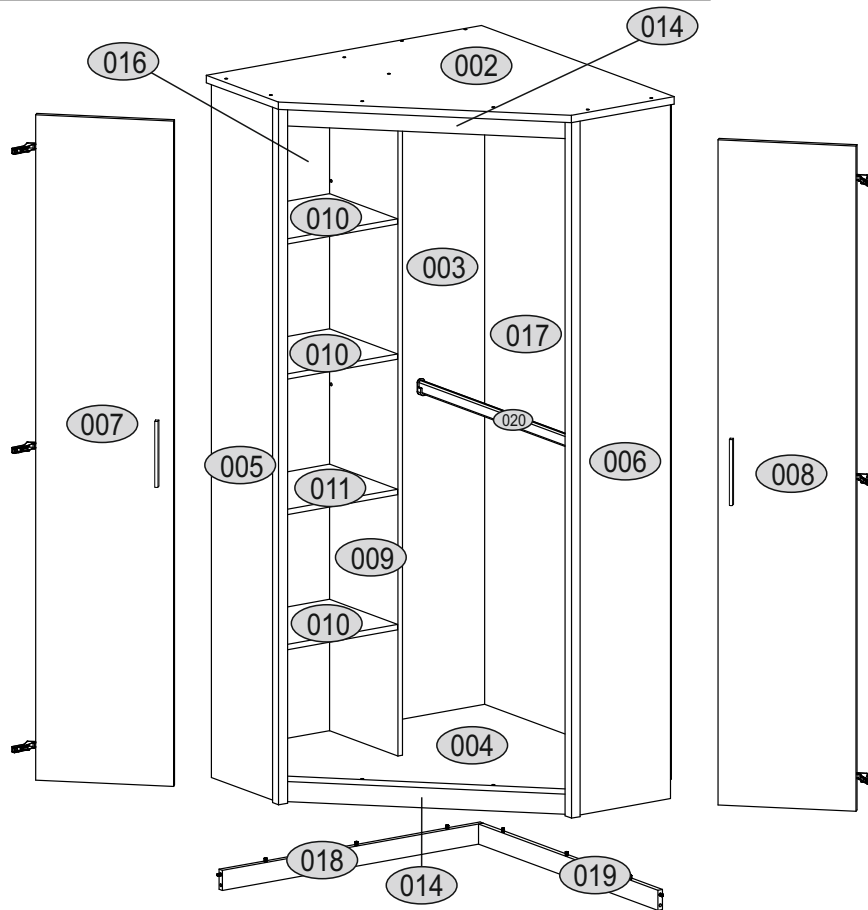

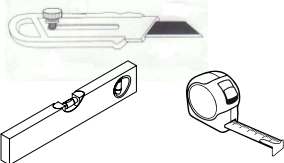

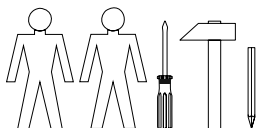



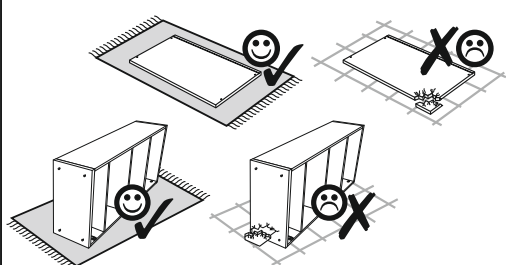
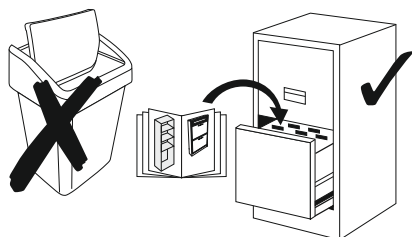







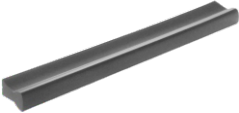

Installation manual

AYSON: szafa narożna 2d



Code	Dimensions			Package
002	969	969	22	1 / 3/3
003	2002	519	16	1 / 1/3
004	935	935	16	1 / 3/3
005	2078	360	16/32	1 / 2/3
006	2078	360	16/32	1 / 2/3
007	1987	404	16	1 / 2/3
008	1987	404	16	1 / 2/3
009	2002	344	16	1 / 1/3
010	400	342	16	3 / 1/3
011	400	342	16	1 / 1/3
014	847	60	16	2 / 1/3
016	2032	419	3	1 / 1/3
017	2032	472	3	2 / 1/3
018	919	60	16	1 / 1/3
019	903	60	16	1 / 1/3
020	914			2 / 1/3
accessories				1 / 1/3



<p>x22 e1</p> <p>Ø7x50 mm</p> 	<p>x7 s1</p> 	<p>x9 r1</p> <p>Ø15x12 mm</p> 	<p>x9 r16</p> 
<p>x2 s2</p> 	<p>x31 f1</p> <p>Ø8x30 mm</p> 	<p>x2 c412.030</p> 	<p>x4 p42</p> <p>Ø 3,5x25mm</p> 
<p>x22 p25</p> <p>Ø3.5x16 mm</p> 	<p>x6 a16</p> 	<p>x6 b6</p> 	<p>x4 n301</p> 
<p>x12 d1</p> 	<p>x10 k1</p> 	<p>x60 l1</p> 	<p>x1 z1</p> 
<p>x1 p17</p> <p>Ø 6x60 mm</p> 	<p>x1 n14</p> 	<p>x1 f3</p> <p>Ø10x50 mm</p> 	

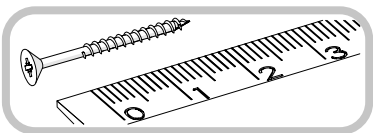

5

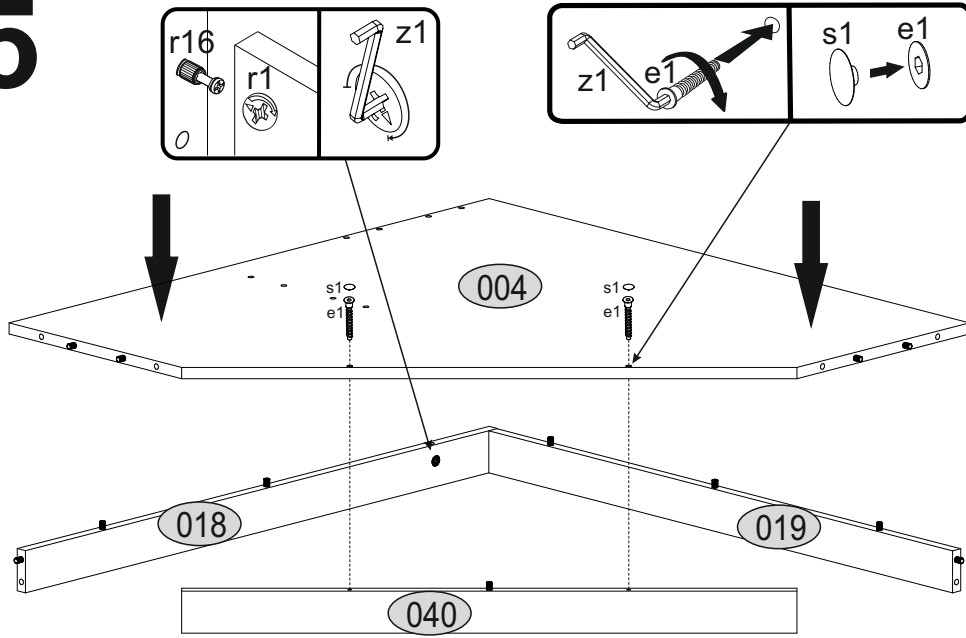

6

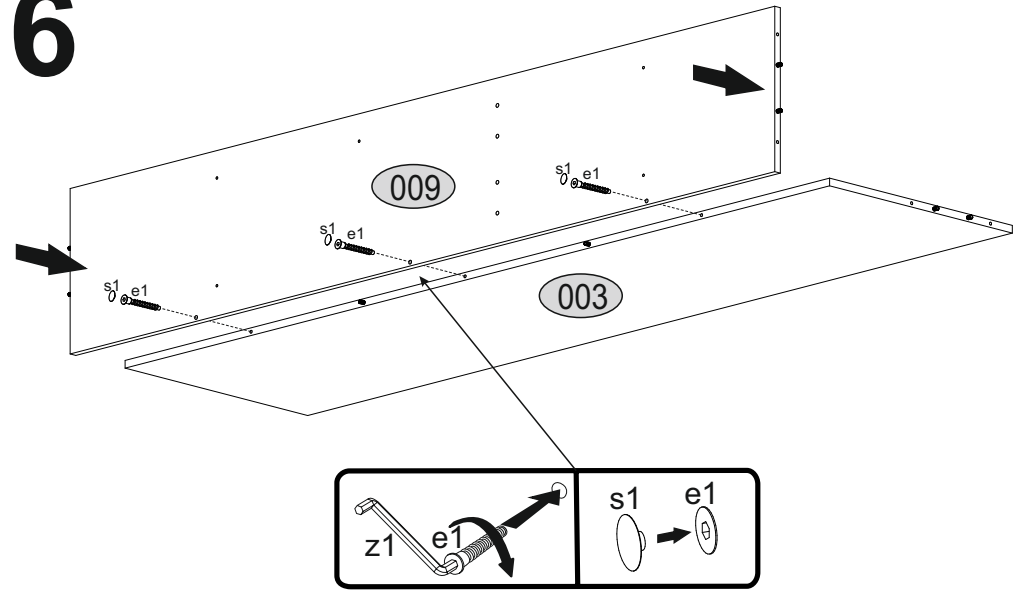

7

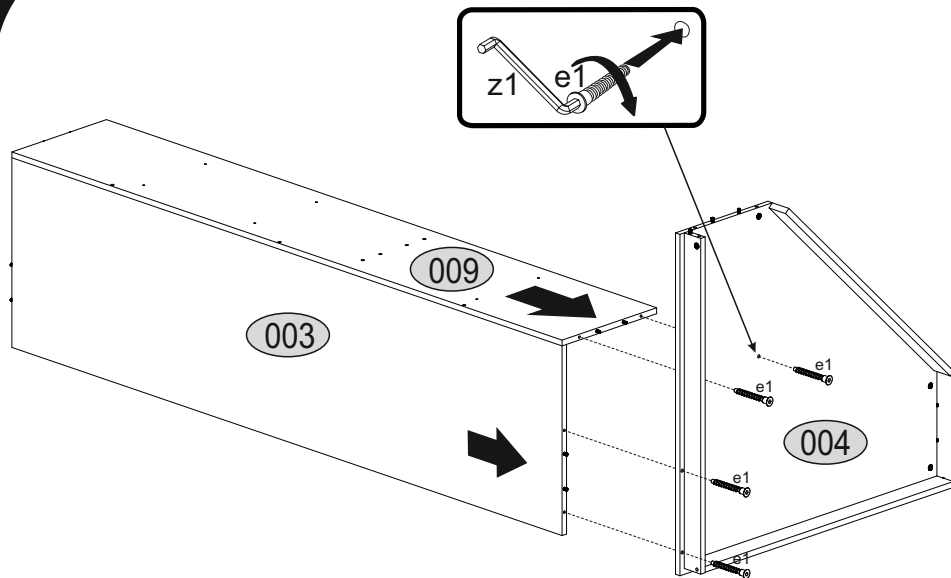

8

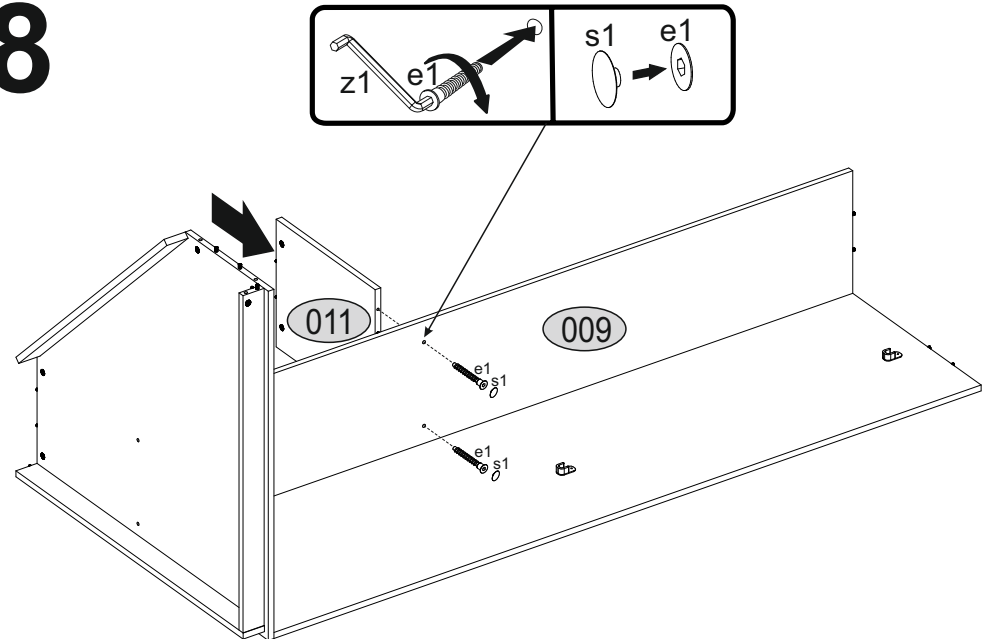

9

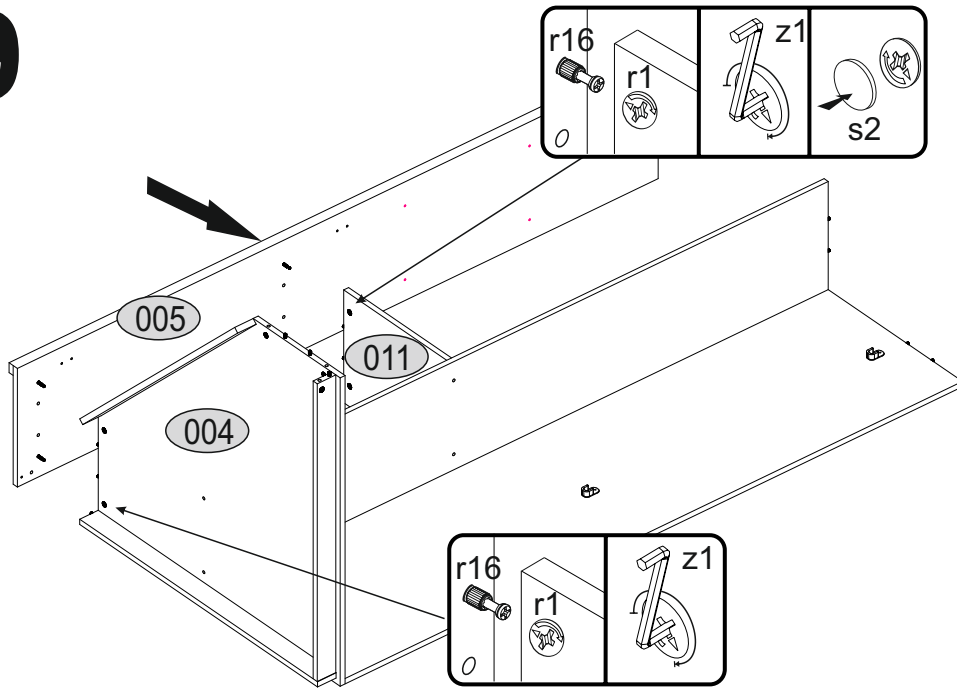

10

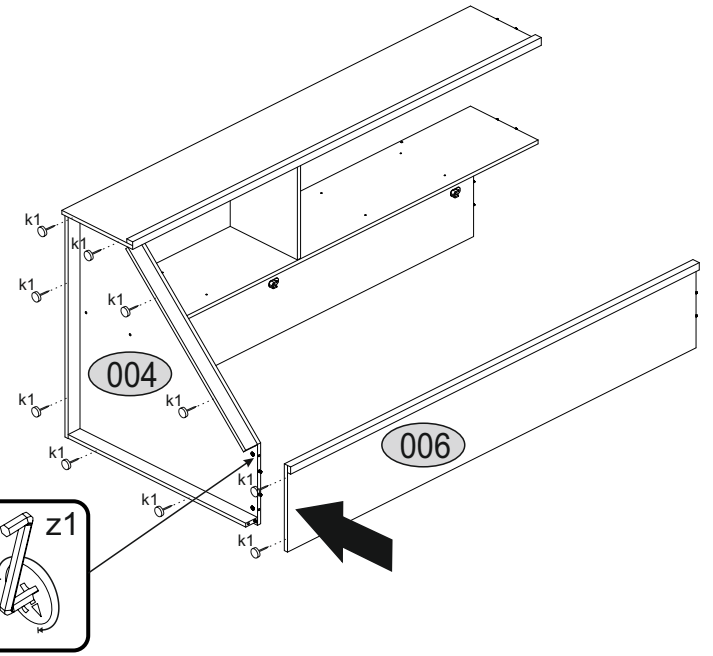

11

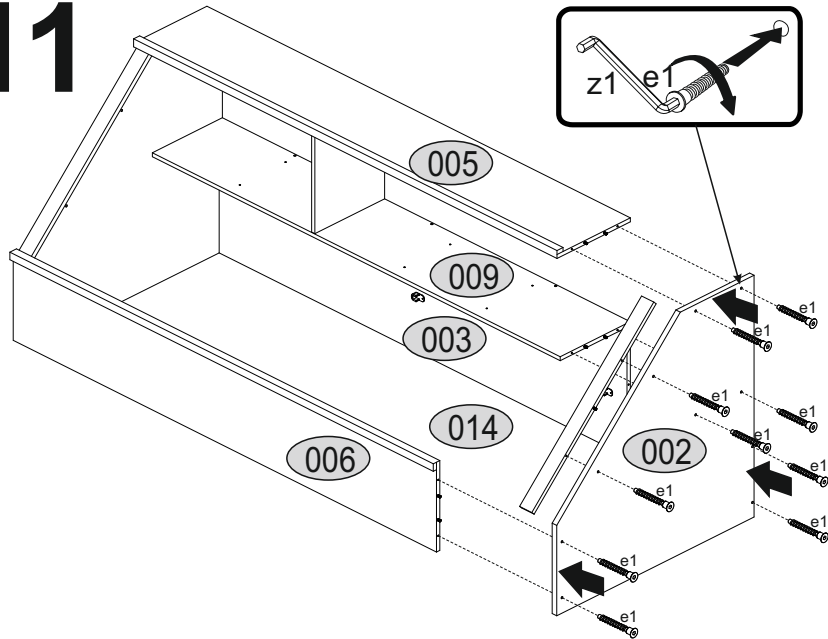

12

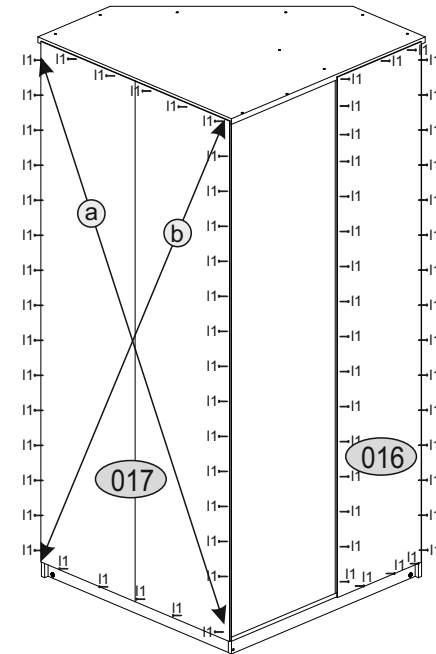
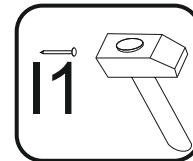
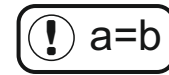

13

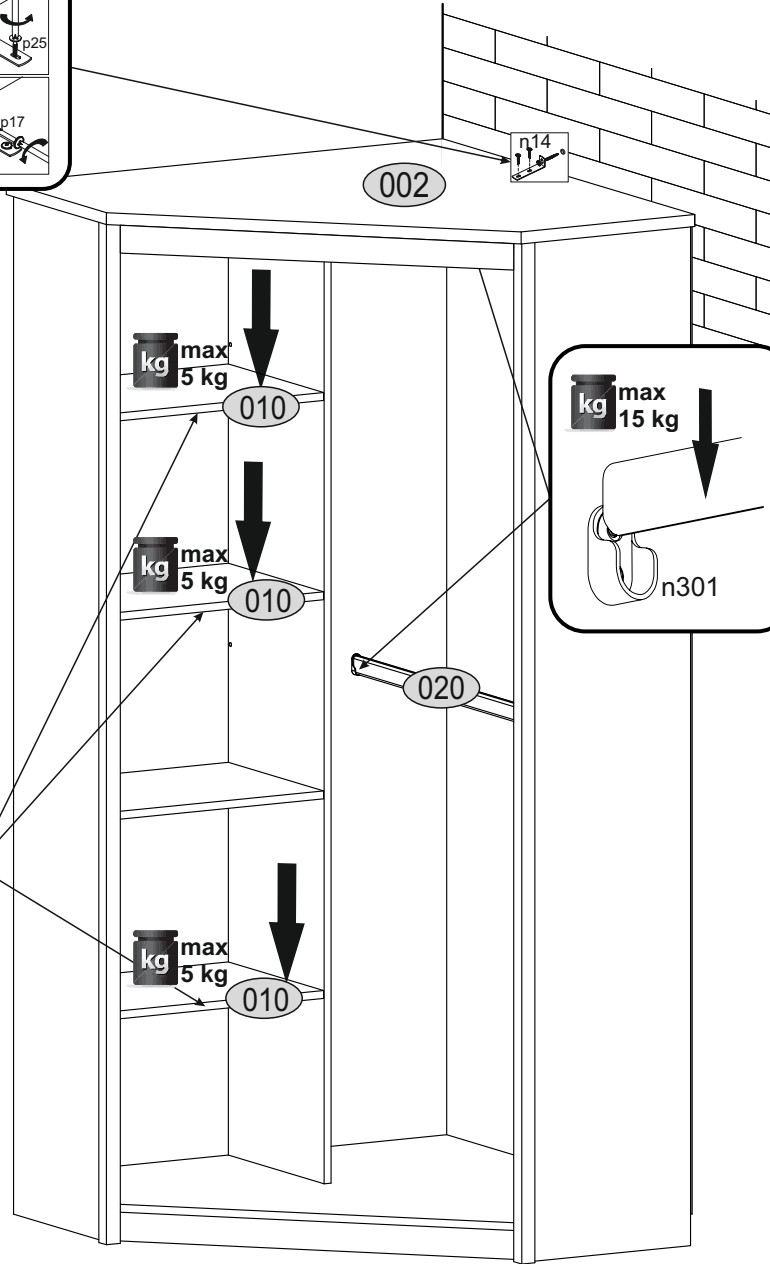
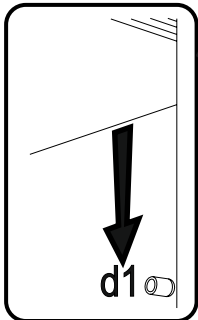
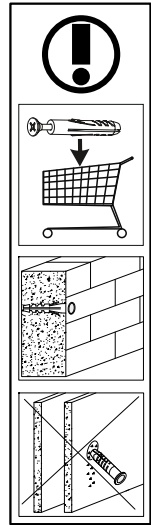
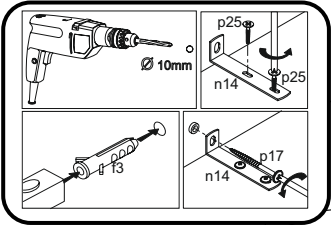

14

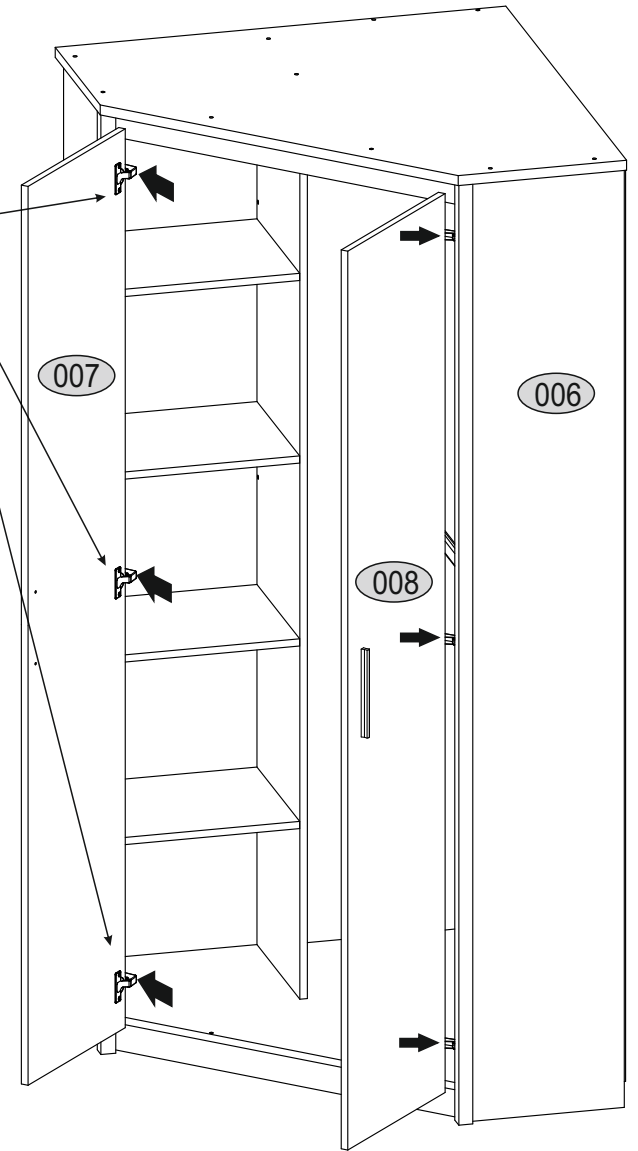
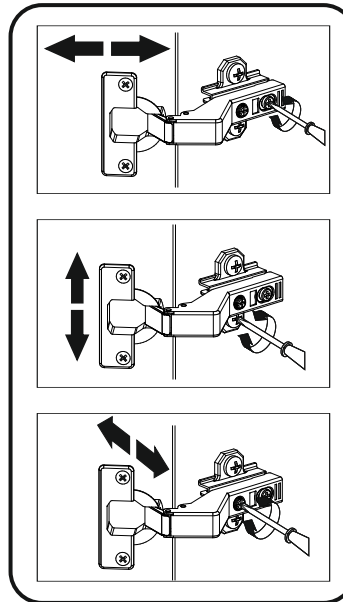
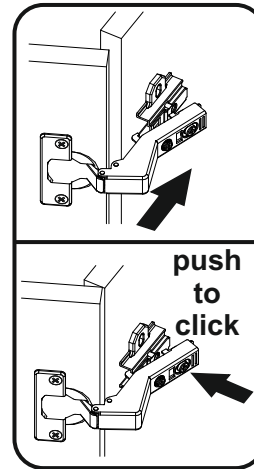

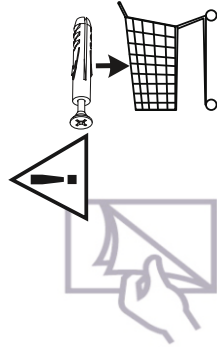
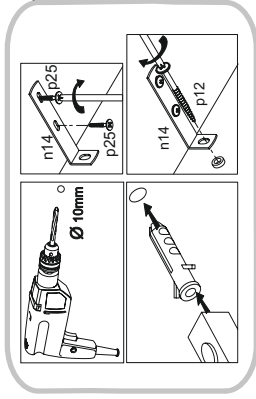
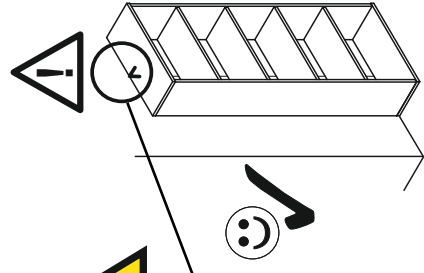
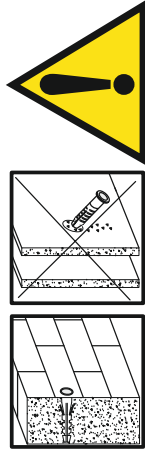

PL.
UWAGA! Mebel należy trwale zamocować do ściany, aby uniknąć ryzyka związanego z przewróceniem się mebla. W paczce nie ma śrub mocujących, ponieważ rodzaj mocowania należy odpowiednio dobrać do rodzaju ściany. Dobierz właściwe do Twojego rodzaju ściany.

SK.
POZOR! Nábytek musí byť trvalo pripevnený k stene tak, aby sa zamedzilo riziku prevrátenia. Balík neobsahuje upevňovacie skrutky, pretože typ upevnenia je treba vybrať podľa typu steny. Vyberte typ vhodný pre Vašu stenu.

FR.
ATTENTION! Ce meuble doit être fixé en permanence au mur pour éviter les risques de chute. Les vis de fixation ne sont pas livrées car le type de fixation doit être choisi en fonction du type de mur. Sélectionnez les fixations adaptées au mur.

HU.
FIGYELEM! Rögzítse a bútorokat a falhoz, hogy elkerülje a bűtor felborulásának kockázatát. A készletben nem találhatóak rögzítőcsavarok, mivel a rögzítés típusa a fal típusától függ. Válassza ki a fal típusának megfelelő kötőelemeket.

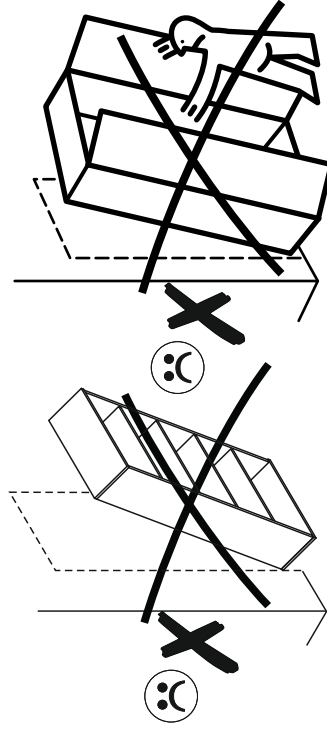

HR.
NAPOMENA! Namještaj mora biti trajno pričvršćen za zid, kako bi se izbjegao rizik od njegova prevrtanja. U paketu nema vijaka za pričvršćivanje, jer se vista montaže mora prilagoditi vrsti zida. Odaberite pravu vistu prema Vašoj vrsti zida.

E.
¡ATENCIÓN! El mueble debe ser fijado permanentemente a la pared para evitar el riesgo relacionado con el vuelco del mueble. En el paquete no hay tornillos de fijación, ya que se debe elegir el tipo de fijación adecuado para el tipo de pared. Elija el apropiado para su tipo de pared.

CN.
注意！本家具需要固定在墙上以免倒塌。箱子里没有安装螺钉，因为安装方式需要根据墙的类型调整。请按您的墙类型选择合适的安装方式。

RU.
ПРИМЕЧАНИЕ! Эту мебель необходимо всегда прикреплять к стене, чтобы избежать рисков, связанных с переворотом мебели. В пакете нет крепежных винтов, потому что тип крепления должен быть выбран в соответствии с типом стены. Выберите, пожалуйста, правильные винты к вашей стене.

SLO.
POZOR! Pohištvo trajno pritrdite na steno, da preprečite tveganje, da se prevrne. V paketu ni pritrdilnih vijakov, saj je treba način pritrditve ustrezno izbrati glede na vrsto stene. Izberite način, ki je ustrezen za vašo steno.

I.
ATTENZIONE! Il mobile deve essere permanentemente fissato alla parete per evitare i rischi derivanti da un ribaltamento del mobile. La confezione non include le viti di fissaggio, in quanto il tipo di fissaggio deve essere scelto in base al tipo di parete. Utilizzare viti appropriate in base al materiale della parete.

EN.
WARNING! To prevent this furniture from tripping over, fix it to the wall permanently. Fixing devices are not included since different wall materials require different types of fixing devices. Please make sure you choose the correct ones for your type of wall.

D.
ACHTUNG! Um alle mit dem Umkippen des Möbels verbundenen Risiken auszuschließen, muss das Möbel fest an der Wand verankert werden.

Beschläge für die Wandbefestigung sind nicht beigebracht, da diese von der jeweiligen Wandbeschaffenheit abhängig sind. Bitte solche Befestigungsschläge wählen, die für die heimischen Wände geeignet sind.

CZ.
POZOR! Nábytek je nutné pevně připravit ke zdi, abychom se vyhnuli riziku spojenému s jeho převrhnutím. Součástí balení nejsou připravnací šrouby, protože způsobu připravení je nutné zvolit podle druhu stěny. Vyberte správný pro Váš typ stěny.

UA.
Примітка. Цю мебель необхідно завжди прикріплювати до стіни, щоб уникнути ризиків, пов'язаних з падінням мебелі. У пакеті немає кріпильних гвинтів, тому що тип кріплення повинно бути вибрано відповідно до типу стіни. Виберіть, будь ласка відповідні гвинти до вашої стіни.